

(1) The line drawings for 10014

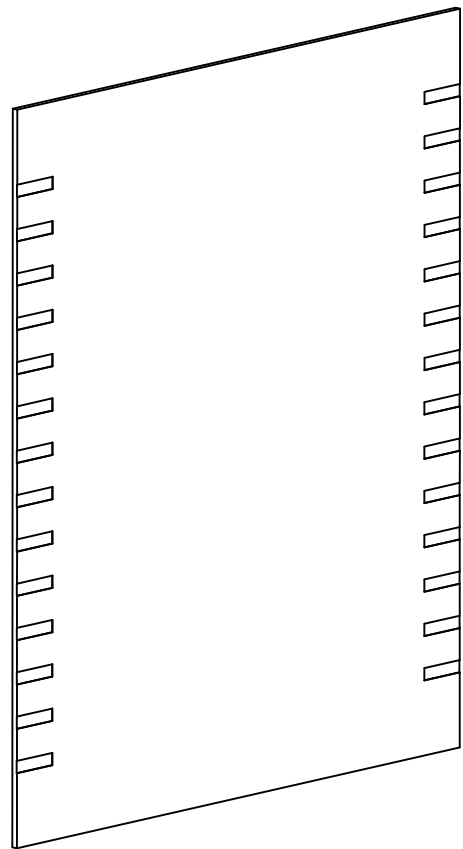

(2)10014(mirror) can be used vertically,please see the line drawings as below:

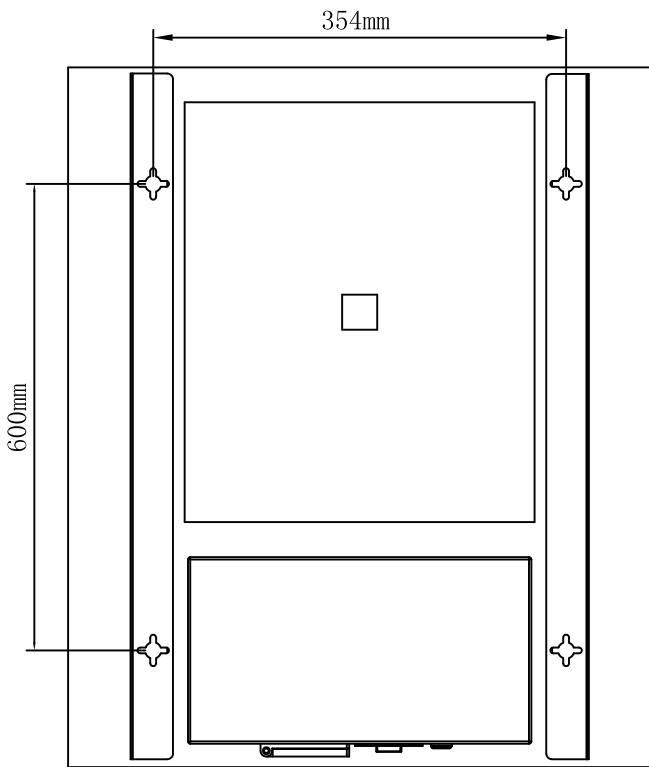
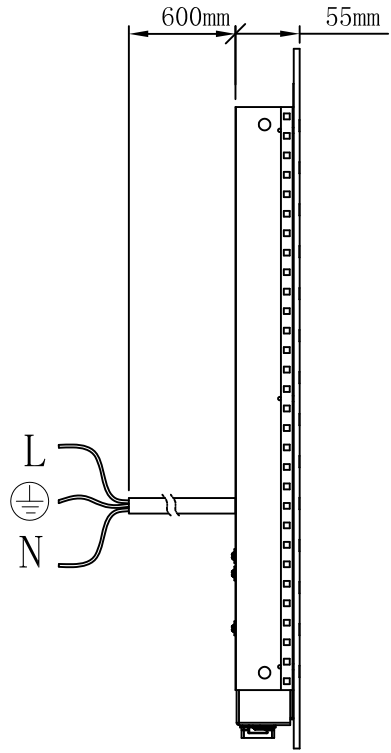
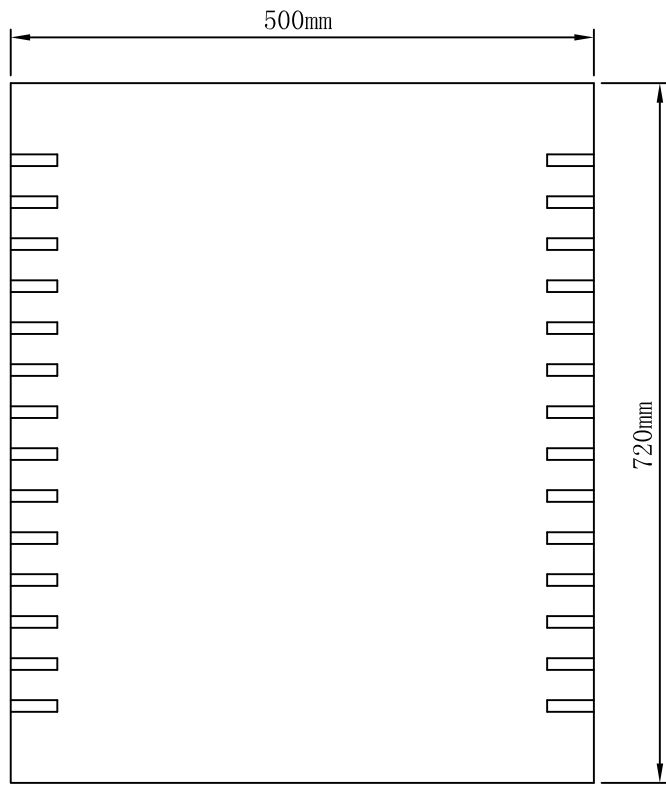
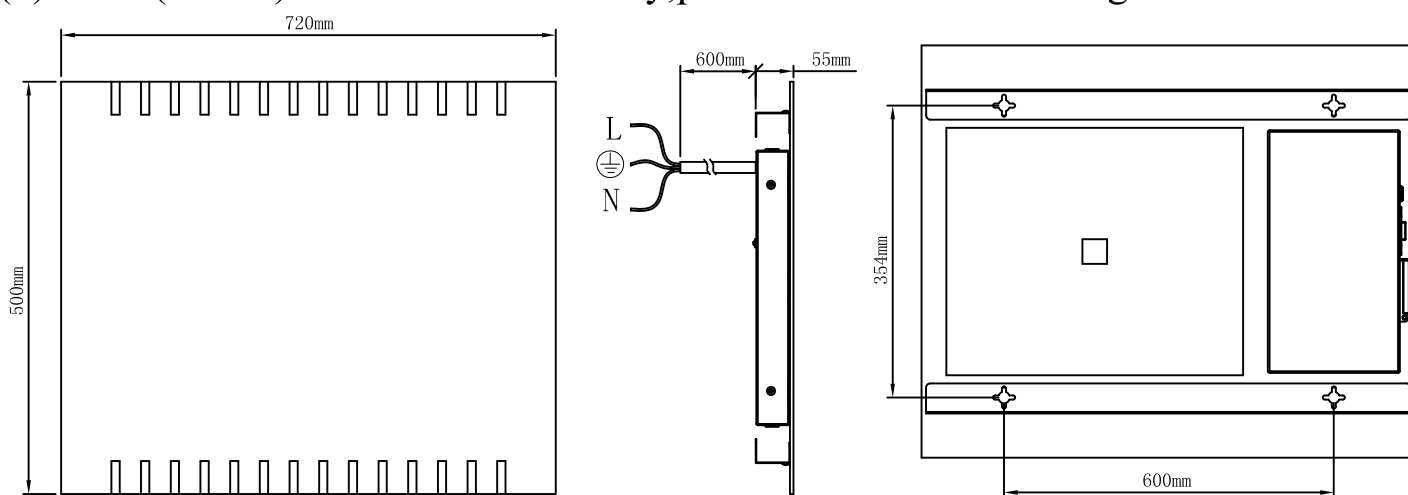

Remarks:The fixing sizes are same as the horizontal mirror (10014),but one is horizontal installation,another is vertical installation

Installation Instructions

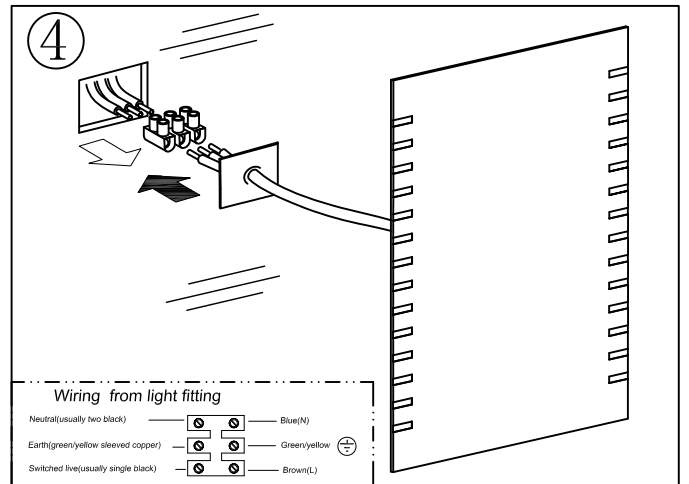
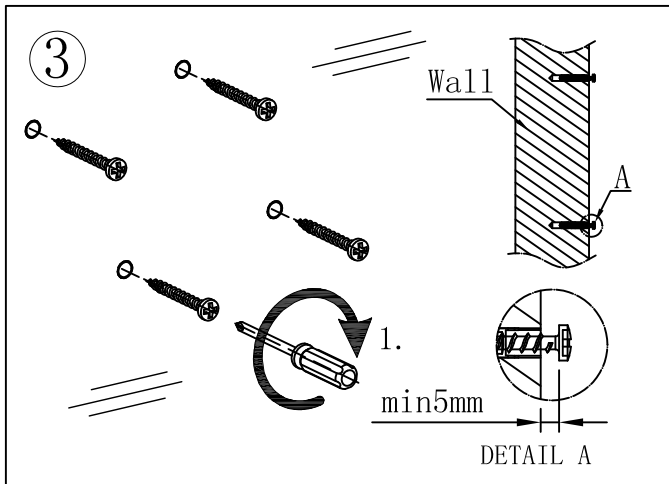
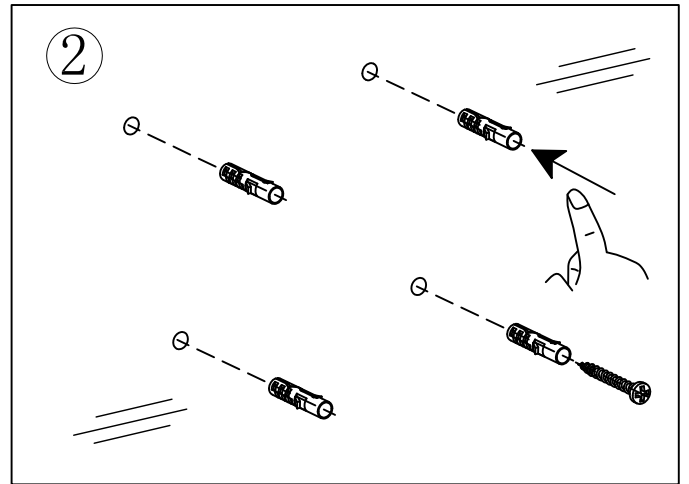
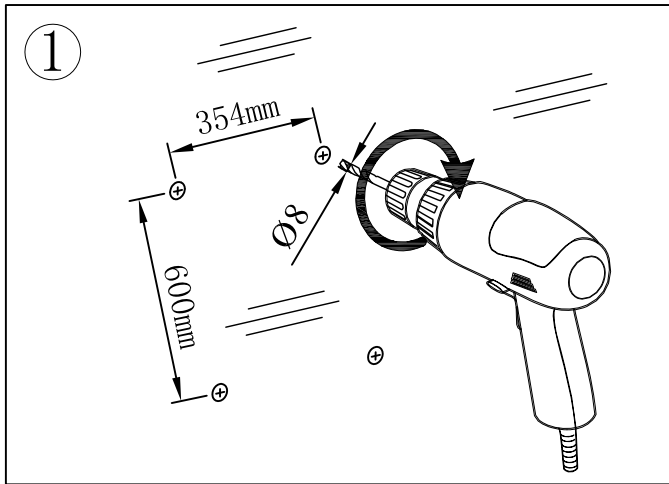

5

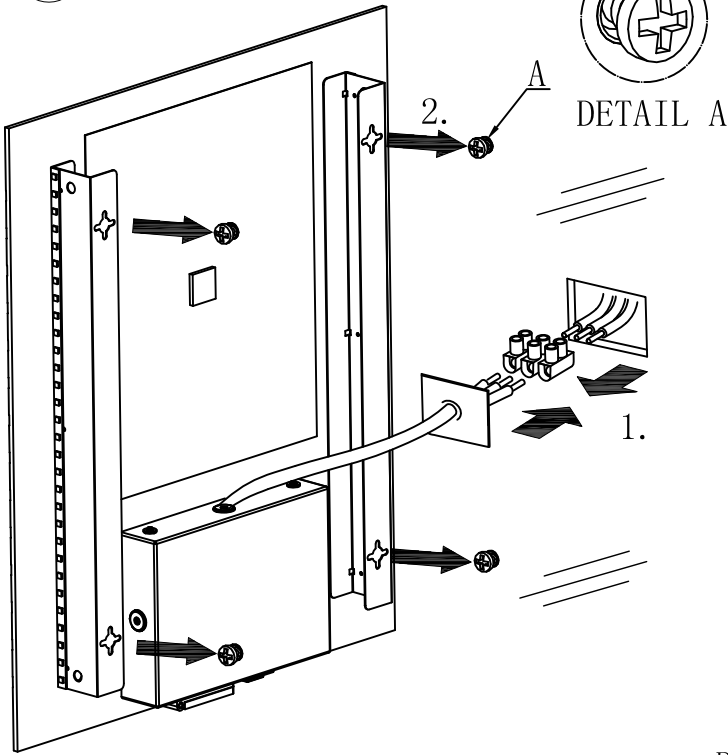

6

